



**Cambridge International Examinations**  
Cambridge International General Certificate of Secondary Education

CANDIDATE  
NAME

--

CENTRE  
NUMBER

--	--	--	--	--

CANDIDATE  
NUMBER

--	--	--	--

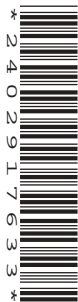

**MATHEMATICS**

**0580/23**

Paper 2 (Extended)

**October/November 2016**

**1 hour 30 minutes**

Candidates answer on the Question Paper.

Additional Materials:      Electronic calculator  
   Tracing paper (optional)

Geometrical instruments

**READ THESE INSTRUCTIONS FIRST**

Write your Centre number, candidate number and name on all the work you hand in.

Write in dark blue or black pen.

You may use an HB pencil for any diagrams or graphs.

Do not use staples, paper clips, glue or correction fluid.

**DO NOT WRITE IN ANY BARCODES.**

Answer **all** questions.

If working is needed for any question it must be shown below that question.

Electronic calculators should be used.

If the degree of accuracy is not specified in the question, and if the answer is not exact, give the answer to three significant figures. Give answers in degrees to one decimal place.

For  $\pi$ , use either your calculator value or 3.142.

At the end of the examination, fasten all your work securely together.

The number of marks is given in brackets [ ] at the end of each question or part question.

The total of the marks for this paper is 70.

The syllabus is approved for use in England, Wales and Northern Ireland as a Cambridge International Level 1/Level 2 Certificate.

This document consists of **15** printed pages and **1** blank page.

1  $V = 4p^2$

Find  $V$  when  $p = 3$ .

$V = \dots\dots\dots$  [1]

2 Simplify.  
 $n^2 \times n^5$

$\dots\dots\dots$  [1]

3

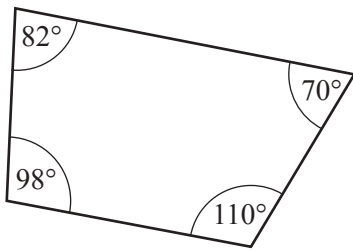

A

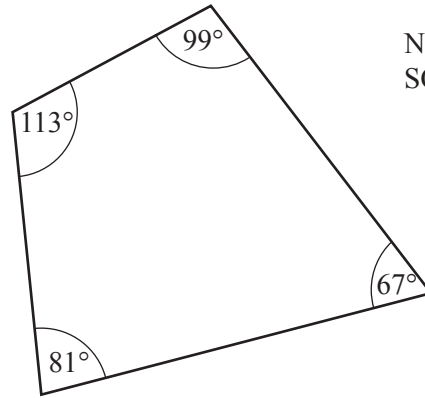

B

NOT TO SCALE

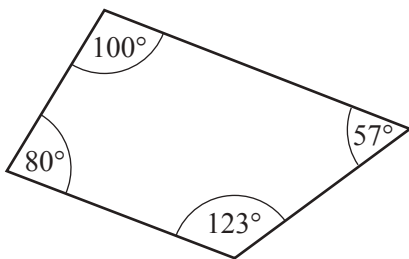

C

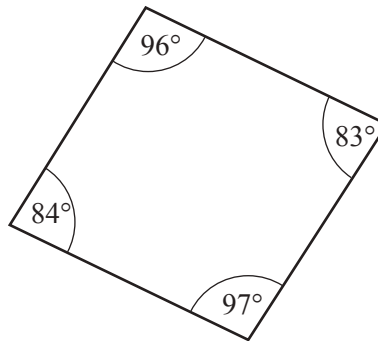

D

The diagram shows four quadrilaterals  $A$ ,  $B$ ,  $C$  and  $D$ .

Which one of these could be a cyclic quadrilateral?

$\dots\dots\dots$  [1]

4 Write in standard form.

(a) 2 470 000

..... [1]

(b) 0.0079

..... [1]

5 Without using a calculator, work out  $\frac{3}{5} + \frac{1}{6}$ .

Write down all the steps of your working and give your answer as a fraction in its simplest form.

..... [2]

6 James is an animal doctor.

The table shows some information about the cats he saw in one week.

Day	Monday	Tuesday	Wednesday	Thursday	Friday
Number of cats seen	2	4	1	3	2
Mean mass of a cat (kg)	1.9	0.9	2.1	1.8	2

One of the cats James saw had a mass of 4 kg.

On which day did he see this cat?

..... [2]

7 Write these in order of size, smallest first.

$0.6^3$

$0.22$

$\sqrt{0.09}$

$0.4^2$

..... < ..... < ..... < ..... [2]  
*smallest*

8 The length of a car is 4.2 m, correct to 1 decimal place.

Write down the upper bound and the lower bound of the length of this car.

Upper bound = ..... m

Lower bound = ..... m [2]

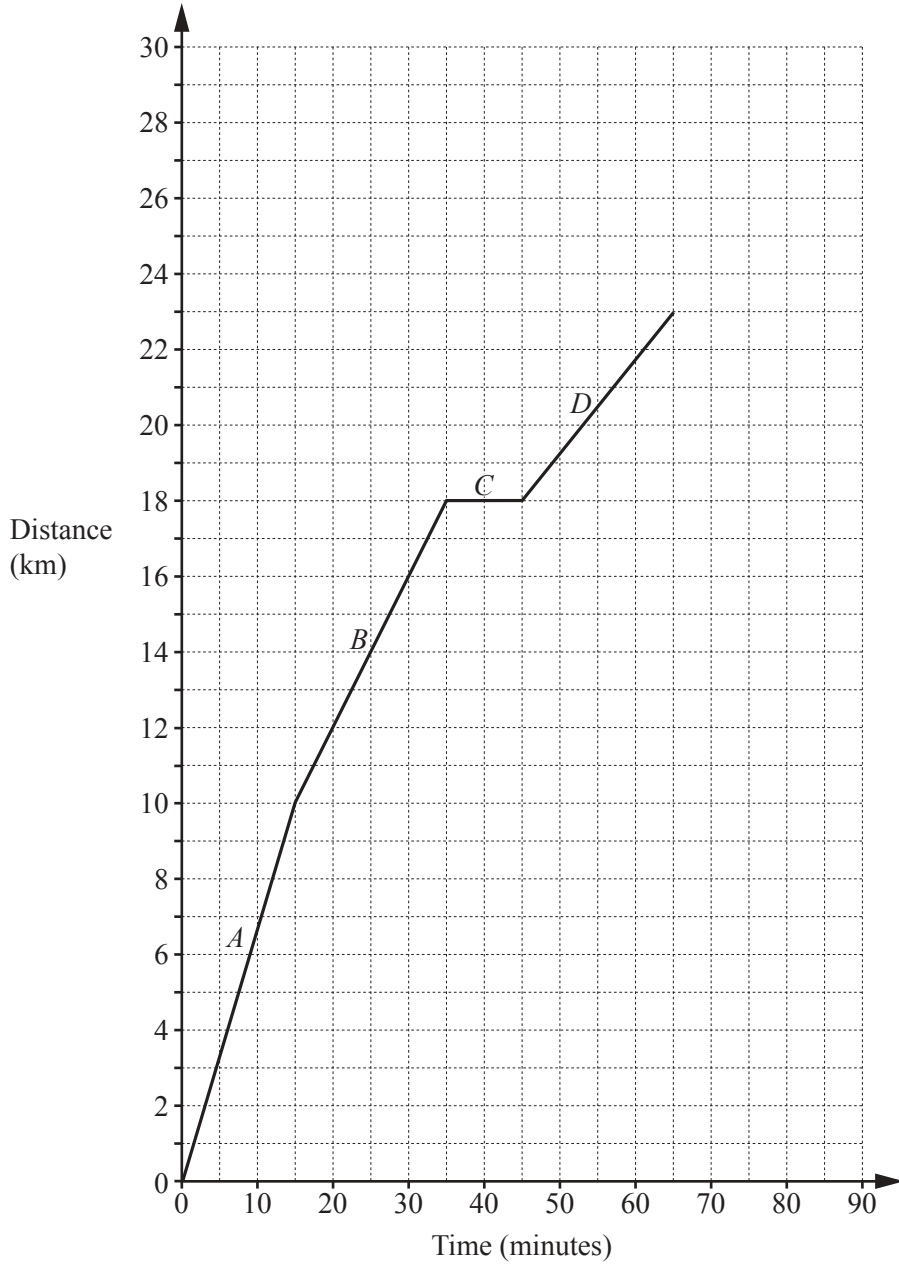

The diagram shows the distance-time graph for the first 65 minutes of a bicycle journey.

- (a) There are four different parts to the journey labelled *A*, *B*, *C* and *D*.

Write down the part of the journey with the fastest speed.

..... [1]

- (b) After the first 65 minutes the bicycle travels at a constant speed of 20 km/h for 15 minutes.

Draw this part of the journey on the diagram.

[1]

10 Calculate.

(a)  $2^3 - \sqrt{10+4^2}$

..... [1]

(b)  $\frac{2\sqrt{3} \times \tan 70^\circ}{3}$

..... [1]

11 Ahmed paid \$34 000 for a car.

His car decreased in value by 40% at the end of the first year.

The value at the end of the second year was 10% less than the value at the end of the first year.

Calculate the value of Ahmed's car after 2 years.

\$ ..... [2]

12

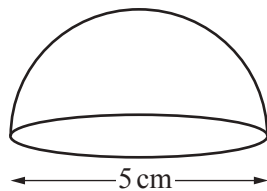

NOT TO  
SCALE

The diagram shows a hemisphere with diameter 5 cm.

Calculate the volume of this hemisphere.

[The volume,  $V$ , of a sphere with radius  $r$  is  $V = \frac{4}{3}\pi r^3$ .]

.....  $\text{cm}^3$  [2]

- 13 Write the recurring decimal  $0.\dot{2}$  as a fraction.  
 [ $0.\dot{2}$  means  $0.222\dots$ ]

..... [2]

- 14 The shaded shape is made by joining a square and a rhombus.

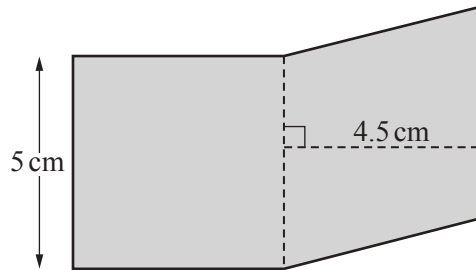

NOT TO  
SCALE

Work out

- (a) the perimeter of the shaded shape,

..... cm [1]

- (b) the area of the shaded shape.

.....  $\text{cm}^2$  [2]

15 (a)

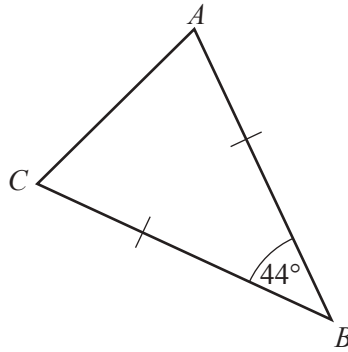
NOT TO  
SCALE

Triangle  $ABC$  is an isosceles triangle with  $AB = CB$ .  
Angle  $ABC = 44^\circ$ .

Find angle  $ACB$ .

Angle  $ACB = \dots\dots\dots$  [1]

(b) A regular polygon has an exterior angle of  $40^\circ$ .

Work out the number of sides of this polygon.

$\dots\dots\dots$  [2]

16  $d$  is inversely proportional to  $(w + 1)^2$ .

$d = 3.2$  when  $w = 4$ .

Find  $d$  when  $w = 7$ .

$d = \dots\dots\dots$  [3]



17  $A$  is the point  $(8, 3)$  and  $B$  is the point  $(12, 1)$ .

Find the equation of the line, perpendicular to the line  $AB$ , which passes through the point  $(0, 0)$ .

..... [3]

18  $f(x) = x^2$        $g(x) = \frac{x-3}{2}$

Find

(a)  $f(-5)$ ,

..... [1]

(b)  $gf(x)$ ,

..... [1]

(c)  $g^{-1}(x)$ .

$g^{-1}(x) =$  ..... [2]

19 The curve  $y = x^3 + 2x^2 - 4x$  is shown on the grid.

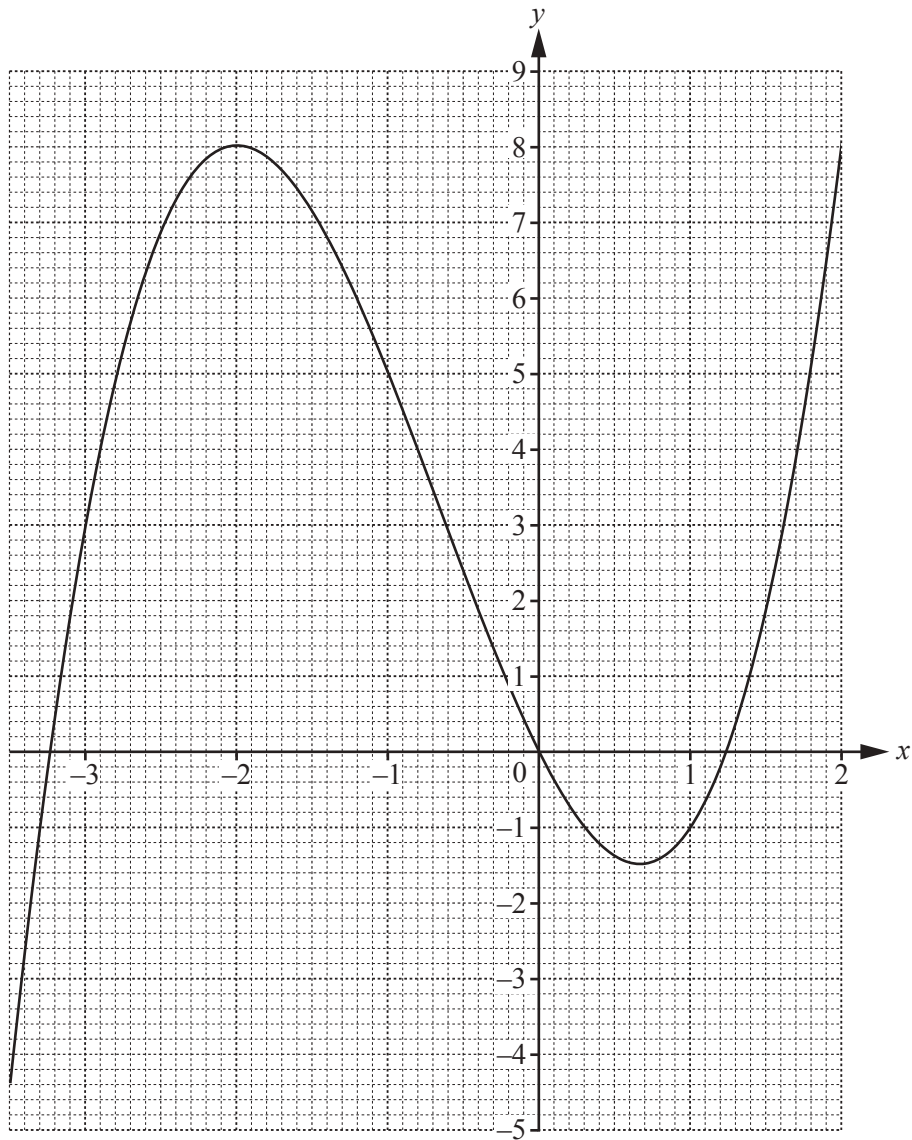

(a) By drawing a suitable tangent, find an estimate of the gradient of the curve when  $x = 1$ .

..... [3]

(b) A point  $D$  lies on the curve.  
 The  $x$  co-ordinate of  $D$  is negative.  
 The gradient of the tangent at  $D$  is 0.

Write down the co-ordinates of  $D$ .

(..... , ..... ) [1]

20 (a)  $\mathcal{E} = \left\{ 7, 9.3, \pi, \frac{5}{9}, 2\sqrt{8} \right\}$

$A = \{\text{integers}\}$

$B = \{\text{irrational numbers}\}$

Write all the elements of  $\mathcal{E}$  in their correct place on the Venn diagram.

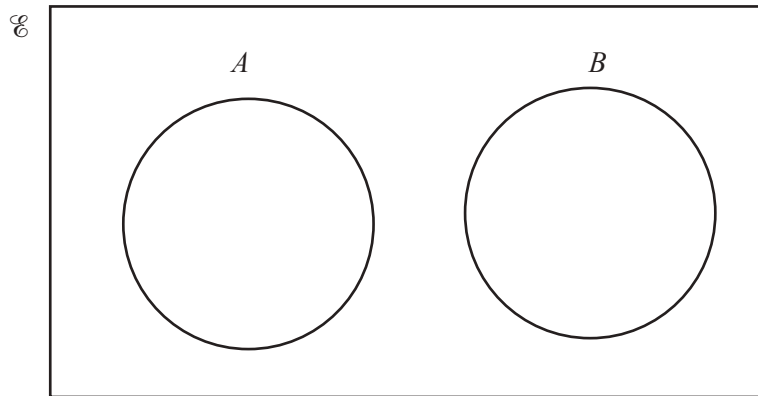

[2]

(b) Shade the region in each of the Venn diagrams below.

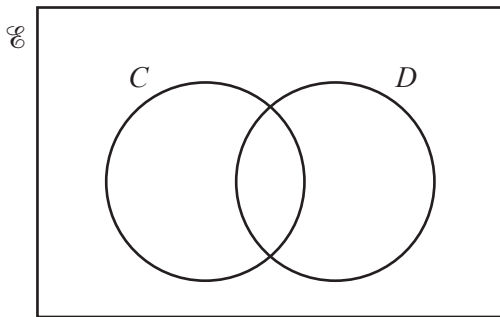

$C' \cup D$

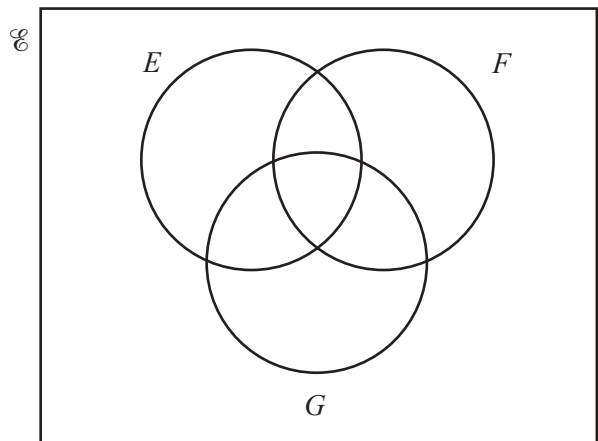

$E \cap F' \cap G$

[2]

21 (a)

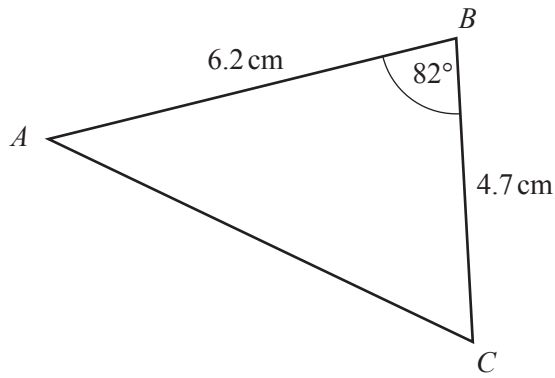

NOT TO SCALE

Calculate the area of triangle *ABC*.

.....cm<sup>2</sup> [2]

(b)

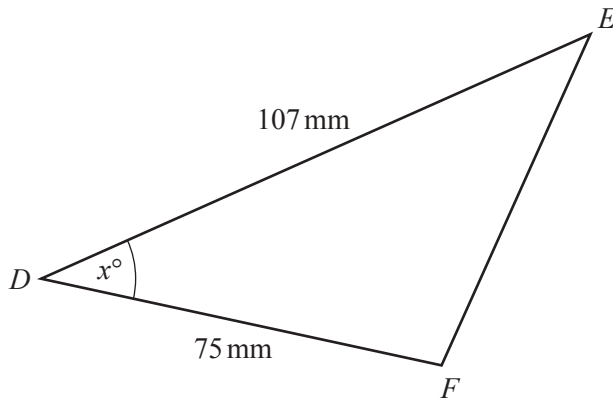

NOT TO SCALE

The area of triangle *DEF* is 2050 mm<sup>2</sup>.

Work out the value of *x*.

$x =$  ..... [2]

- 22 The table shows some information about the mass,  $m$  grams, of 200 bananas.

Mass ( $m$ grams)	$90 < m \leq 110$	$110 < m \leq 120$	$120 < m \leq 125$	$125 < m \leq 140$
Frequency	40	70	60	30
Height of column in histogram (cm)			6	

Complete the table.

[4]

- 23 Simplify. 
$$\frac{42np - 7n}{12pt - 2t + 18mp - 3m}$$

..... [4]

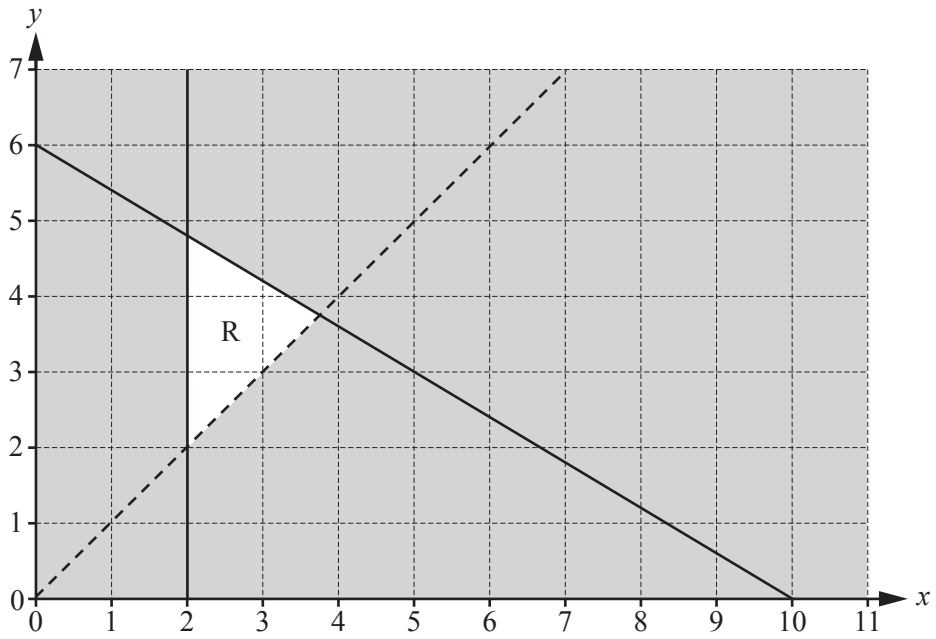

Find the three inequalities that define the unshaded region, R.

.....  
 .....  
 ..... [5]

25  $\mathbf{A} = \begin{pmatrix} 4 & 2 \\ 2 & 1 \end{pmatrix}$        $\mathbf{B} = \begin{pmatrix} 7 & -3 \\ 4 & 5 \end{pmatrix}$        $\mathbf{C} = \begin{pmatrix} -2 & 3 & 1 \\ 4 & 5 & -1 \end{pmatrix}$        $\mathbf{D} = \begin{pmatrix} -9 \\ 0 \end{pmatrix}$

(a) Which of these four matrix calculations is **not** possible?

$\mathbf{A} + \mathbf{B}$

$3\mathbf{C}$

$\mathbf{CB}$

$\mathbf{AD}$

..... [1]

(b) Calculate  $\mathbf{AB}$ .

$\begin{pmatrix} & \\ & \end{pmatrix}$  [2]

(c) Work out  $\mathbf{B}^{-1}$ , the inverse of  $\mathbf{B}$ .

$\begin{pmatrix} & \\ & \end{pmatrix}$  [2]

(d) Explain why matrix  $\mathbf{A}$  does not have an inverse.

..... [1]

**BLANK PAGE**

---

Permission to reproduce items where third-party owned material protected by copyright is included has been sought and cleared where possible. Every reasonable effort has been made by the publisher (UCLES) to trace copyright holders, but if any items requiring clearance have unwittingly been included, the publisher will be pleased to make amends at the earliest possible opportunity.

To avoid the issue of disclosure of answer-related information to candidates, all copyright acknowledgements are reproduced online in the Cambridge International Examinations Copyright Acknowledgements Booklet. This is produced for each series of examinations and is freely available to download at [www.cie.org.uk](http://www.cie.org.uk) after the live examination series.

Cambridge International Examinations is part of the Cambridge Assessment Group. Cambridge Assessment is the brand name of University of Cambridge Local Examinations Syndicate (UCLES), which is itself a department of the University of Cambridge.